



PHONECELL[®] SX6P GSM

• **Fixed Wireless Phone**

**850/1800/1900 MHz GSM (TRI BAND) AND
900/1800/1900 MHz GSM (TRI BAND) MODELS**

USER MANUAL

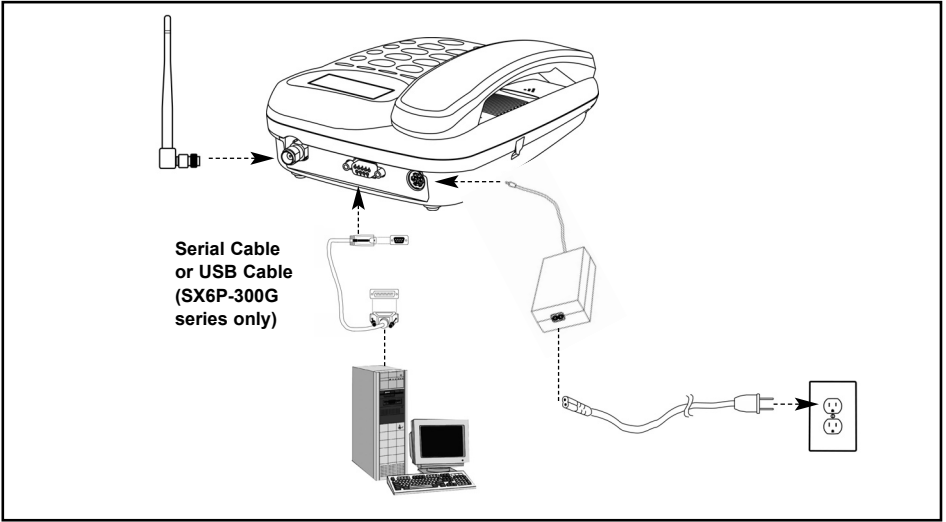

Fixed Wireless Phone

This manual is for use with all SX6P-200G and SX6P-300G series deskphones only. To determine which model of phone you have, pick up the phone and view the label underneath for verification.

SX6P MENU STRUCTURE

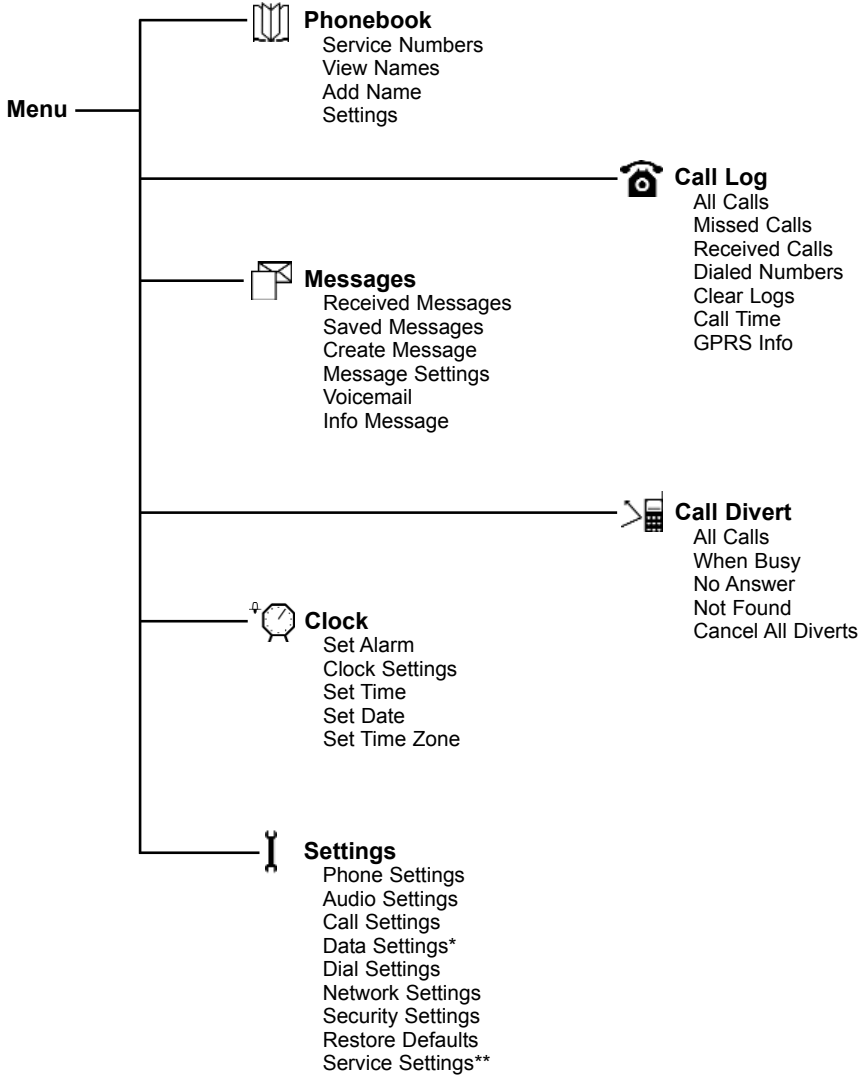

* Not available on SX6P-200G

** Requires password

CONTENTS



Phonecell® SX6P GSM Desktop Phone



Spike Antenna



Power Supply



AC Power Cord

Before installing your **Phonecell® SX6P**, carefully remove the contents from the shipping carton and check for evidence of shipping damage. **If damage is found, contact your Authorized Telular Distributor or shipping agent immediately.**

SAFE OPERATION INSTRUCTIONS

IMPORTANT! Before installing or operating this product, read the **SAFETY INFORMATION** section of this manual.

- Install unit indoors.
- Install unit on hard, flat surface for proper ventilation.
- Do not expose unit to rain or moisture.
- Do not place unit on or close to sources of heat

PLEASE SEE THE IMPORTANT NOTICES SECTION OF THIS MANUAL FOR IMPORTANT INFORMATION ON USE, WARRANTY AND INDEMNIFICATION

IMPORTANT NOTICES

TERMS AND CONDITIONS FOR USE OF PHONECELL® PRODUCTS ("Product")

These Terms and Conditions are a legal contract between you and Telular Corporation for the title to and use of the Product. BY RETAINING AND USING THE PRODUCT AFTER RECEIPT OF IT, YOU AGREE TO THE TERMS AND CONDITIONS INCLUDING WARRANTY DISCLAIMERS, LIMITATIONS OF LIABILITY AND INDEMNIFICATION PROVISIONS BELOW. IF YOU DO NOT AGREE TO THE TERMS AND CONDITIONS, DO NOT USE THE PRODUCT AND IMMEDIATELY RETURN THE UNUSED PRODUCT FOR A COMPLETE REFUND. You agree to accept sole responsibility for any misuse of the Product by you; and, in addition, any negligent or illegal act or omission of your or your agents, contractors, servants, employees, or other users of the Product so long as the Product was obtained from you, in the use and operation of the Product.

INDEMNIFICATION OF TELULAR CORPORATION ("TELULAR")

YOU SHALL INDEMNIFY, DEFEND AND HOLD HARMLESS TELULAR FOR ANY OF THE COST, INCLUDING REASONABLE ATTORNEYS' FEES, AND FROM CLAIMS ARISING OUT OF YOU, YOUR CLIENTS' OR OTHER THIRD PARTIES' USE OR OPERATION OF THE PRODUCT: (i) FOR MISUSE OR IN A MANNER NOT CONTEMPLATED BY YOU AND TELULAR OR INCONSISTENT WITH THE PROVISIONS OF THIS MANUAL; (ii) IN AN ILLEGAL MANNER OR AGAINST PUBLIC POLICY; (iii) IN A MANNER SPECIFICALLY UNAUTHORIZED IN THIS MANUAL; (iv) IN A MANNER HARMFUL OR DANGEROUS TO THIRD PARTIES; (v) FROM CLAIMS BY ANYONE RESPECTING PROBLEMS, ERRORS OR MISTAKES OF THE PRODUCT; OR (vi) COMBINATION OF THE PRODUCT WITH MATERIAL, MODIFICATION OF THE PRODUCT OR USE OF THE PRODUCT IN AN ENVIRONMENT NOT PROVIDED, OR PERMITTED, BY TELULAR IN WRITING. THE PARTIES SHALL GIVE EACH OTHER PROMPT NOTICE OF ANY SUCH COST OR CLAIMS AND COOPERATE, EACH WITH THE OTHER, TO EFFECTUATE THIS INDEMNIFICATION, DEFENSE AND HOLD HARMLESS.

TELULAR CORPORATION

Corporate Headquarters

647 North Lakeview Parkway
Vernon Hills, Illinois 60061, USA

Technical Support

Tel: 847-247-9400 • Fax: 847-247-0021

E-mail: support@telular.com • <http://www.telular.com>

TABLE OF CONTENTS

| | |
|--|------------|
| QUICK CONNECTION GUIDE | i |
| SX6P MENU STRUCTURE | ii |
| CONTENTS | iii |
| SAFE OPERATION INSTRUCTIONS | iii |
| IMPORTANT NOTICES | iii |
| SX6P SETUP | 1 |
| SIM Card Installation | 1 |
| Battery Installation | 1 |
| Battery Operation..... | 2 |
| Location and Setup..... | 2 |
| Connect the Handset..... | 2 |
| Wall-Mounting | 3 |
| Connect the SX6P to AC Power..... | 4 |
| GETTING TO KNOW YOUR SX6P | 5 |
| Function Keys | 5 |
| LCD Screen Icons..... | 6 |
| Service Indication | 6 |
| CALL FUNCTIONS | 7 |
| Making Calls | 7 |
| Receiving Calls..... | 7 |
| Ending Calls..... | 7 |
| In-Call Functions..... | 7 |
| SX6P BASIC FEATURES | 8 |
| Date and Time Settings | 8 |
| Audio Settings..... | 8 |
| Adjust Alert Tones | 9 |
| Speakerphone..... | 9 |
| Phonebook..... | 9 |
| Speed Dialing..... | 11 |
| Change the Display Screen Contrast | 11 |
| ChangeBacklight Options..... | 11 |
| SX6P ADDITIONAL FEATURES | 12 |
| Call Logs..... | 12 |
| Alarm Settings..... | 12 |
| Language Selection | 13 |
| Personalization Options..... | 13 |
| Call Settings..... | 14 |
| Network Settings..... | 15 |
| SIM PIN Setup..... | 16 |
| Handset Call Barring..... | 17 |
| Restricted Dialing..... | 18 |
| Deskphone Lock | 18 |
| Closed User Groups (CUG)..... | 19 |
| Restore Factory Defaults | 19 |

| | |
|---|-----------|
| SUPPLEMENTARY SERVICES (NETWORK DEPENDENT) | 20 |
| In-Call Options | 20 |
| Call Divert (Forwarding)..... | 20 |
| Call Waiting..... | 21 |
| Multiparty Calling | 21 |
| Caller ID Settings..... | 21 |
| Blocking Your Number (CLIR) | 21 |
| Voicemail..... | 22 |
| Short Message Service (SMS) | 22 |
| Information Messages | 24 |
| Network Call Barring..... | 25 |
| DATA FEATURES | 26 |
| Connect SX6P to a Computer | 26 |
| Configure PC for Circuit Switched Data | 26 |
| Automatic Baud Rate Fall Back Control | 26 |
| Digital Fax Setup | 27 |
| GPRS (Packet Data) Connections..... | 27 |
| SX6P TROUBLESHOOTING | 28 |
| CONFORMANCE STATEMENTS | 29 |
| SAFETY INFORMATION | 29 |
| WARRANTY | 32 |
| APPENDIX A: PC SERIAL PORT SETUP FOR CS FAX AND DATA | 34 |

SX6P SETUP

SIM Card Installation

The SX6P requires a Subscriber Identification Module (SIM) for normal operation. The service provider supplies the SIM card, which carries the account information needed to operate the SX6P. The SIM compartment is on the back of the SX6P.

NOTE: If you don't have a SIM card, contact your network service provider.

1. Make sure the unit is off and the power supply disconnected before removing or installing a SIM Card.
2. Remove the SIM compartment cover by removing the screw.
3. Open the SIM compartment holder.
4. Line up the SIM card with the arrow on the SIM card holder - **see Figure 1.**
5. Gently insert the SIM card in the slot of the SIM card holder.
6. Close the SIM card holder.

NOTE: Do not force the SIM card holder shut. Make sure the SIM card is aligned properly with the directional arrow on the holder.

7. Reattach the SIM compartment cover with the screw.

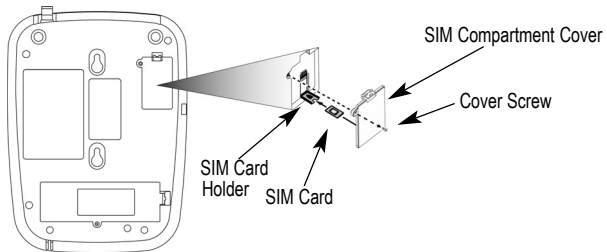



Figure 1 - SIM card installation.

Install Batteries (optional)

1. Remove the battery access door screw located on the bottom of the unit - **see Figure 2.**
2. Press the battery access door tabs and remove the battery access door.
3. Install the Telular 3.6V rechargeable battery pack into the battery pack area.
4. Reinstall the battery access door using the screw - **see Figure 3.**



WARNING!
Do not use batteries other than the included Telular battery pack with the SX6P. Using any other batteries may result in fire and/or other damage to the unit.

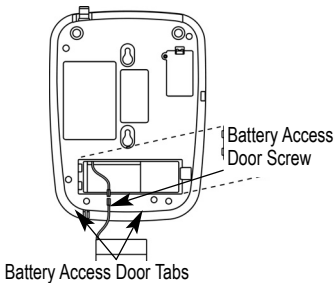

Figure 2 – Battery access door.

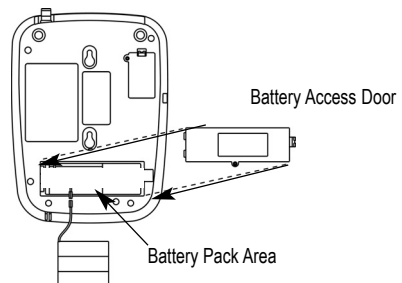

Figure 3 - Battery installation.

Battery Operation

The SX6P will recharge its battery pack when connected to AC power. If AC power is interrupted, the SX6P will continue to operate, using power from the battery. (Standby and talk-times will vary based upon phone usage during power interruption.)

Location and Setup

The SX6P comes with a standard spike antenna (TNC).

NOTE: The supplied antenna will support either 850/1900 MHz or 900/1800 MHz frequencies, as specified by your wireless service network provider.

1. Attach and finger-tighten the antenna - **see Figure 4**. Do not over-tighten the antenna.
2. Select a location that is above ground and as close to windows (or exterior walls) as possible to get the best signal - **see Figure 5**.

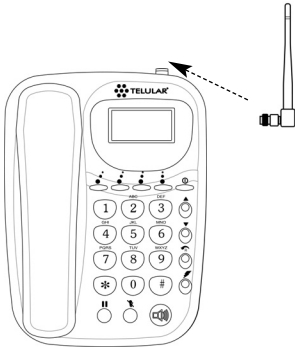

Figure 4 - Attach the antenna.

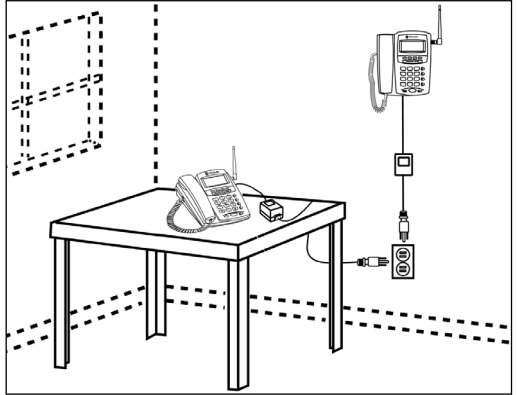

Figure 5 - SX6P location.

Connect the Handset

Before you can use the SX6P, you must connect the handset cable.

1. Connect the handset cable to the phone jack - **see Figure 6**.
2. Connect the handset cable to the handset - **see Figure 6**.

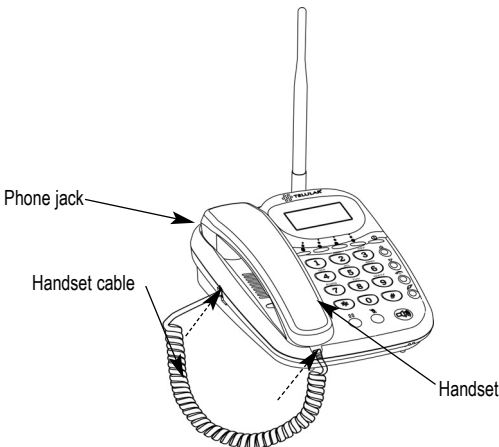
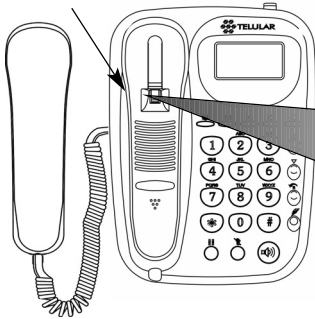

Figure 6- SX6P handset connection.

Wall-Mounting

1. Remove the mounting clip from the cradle and re-insert it with the tab pointing up - see **Figures 7 and 8.**

Mounting Clip in Cradle (tab up)



Remove Mounting Clip from the Cradle (tab down)

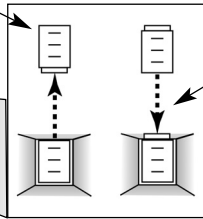

Insert Mounting Clip into the Cradle (tab up)

Figure 7 – Handset mounting clip assembly.

Figure 8 – Handset mounting clip for wall-mount.

2. Mark two hole locations 83 mm (3-1/4 inches) vertically apart and drill two holes into the wall.
3. Install the screws (not supplied) into the wall, leaving a gap of approximately 3 mm (1/8 inches) between the screw head and the wall.
6. Align the mounting holes with the screws and mount the SX6P onto the screws - see **Figures 9 and 10.**

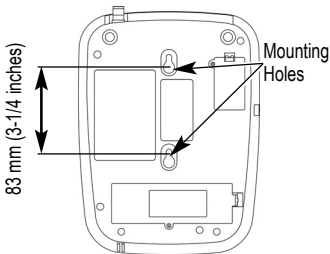

Figure 9 – SX6P mounting hooks.

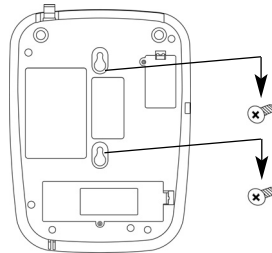

Figure 10 – Mount the SX6P onto the screws.

Connect the SX6P to AC Power

1. Connect the barrel connector of the power supply to the AC power input on the rear panel of the SX6P - **see Figure 11**.
2. Plug the AC power cord into the power supply.
3. Plug the AC power cord into the wall socket.
4. Press and hold the ON/OFF button for 3 to 5 seconds.
5. Check the cellular signal strength and move the unit until the best signal possible is achieved - see the *Service Indication* section of this manual.

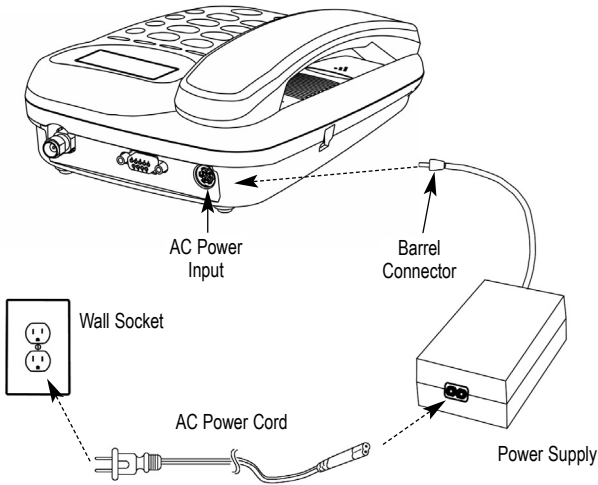

Figure 11 – SX6P AC power connection.

GETTING TO KNOW YOUR SX6P

Function Keys

Operation of the SX6P is accomplished through the function keys on the keypad of the unit - **see Figure 12.**

LCD Screen - Displays icons, information, and menu options necessary to operate the SX6P.

Power - Used to power unit On and Off.

Volume - Controls the speaker volume level for the handset and the speakerphone when the SX6P is off-hook.

LCD Soft Keys - Provide access to the SX6P menu options and features.

Redial - Dials the last number called from the SX6P.

Hold - Used to put the active call on hold or to reactivate an on-hold call.

Flash - Allows answering of call waiting, connecting multiparty calls, and putting an active call on hold to make another call. Also can be used to skip Dial Delay time (quick dial).

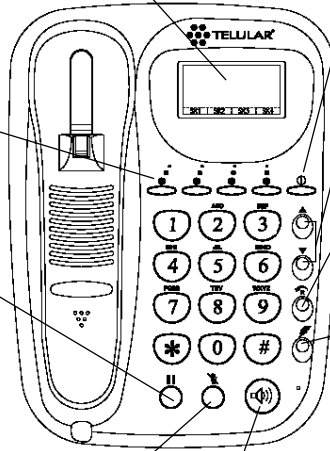

Mute - Prevents the party on the other end of a call from hearing any sound from the SX6P.

Speakerphone - Engages the speakerphone feature.

Figure 12 – SX6P keypad and function keys.

LCD Screen Icons

Icons displayed on the LCD screen indicate the features in use, the status of the phone, signal strength and battery status - see **Figure 13**.

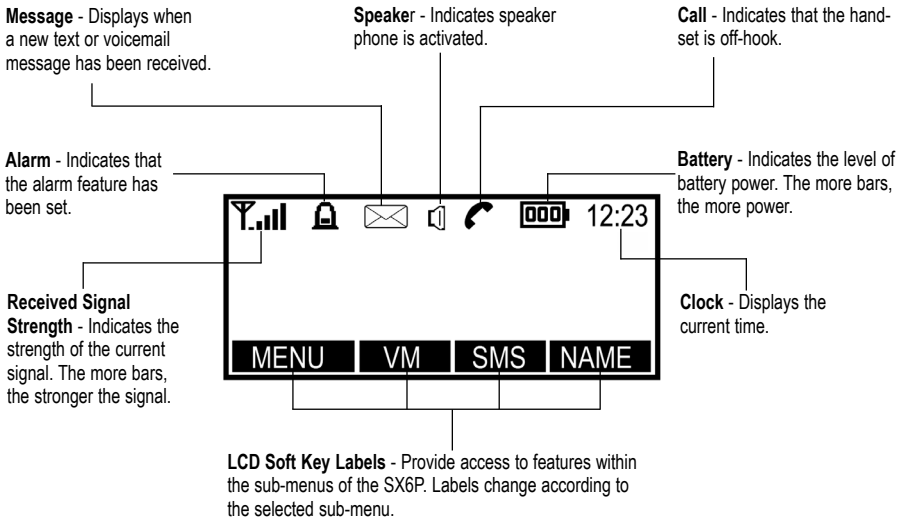

Figure 13 – SX6P LCD screen icons.

Service Indication

Full Service

When powered on, the SX6P will display a wakeup banner (the 300G models LCD screen and keypad backlight will also light). After a few seconds, the greeting and mobile carrier will display. If service is available, the antenna icon will display indicator bars. The number and height of the indicator bars increases as the signal grows stronger (the more bars, the better the signal).

No Service

When no service is available, the antenna icon will not display any bars. Contact your service provider to verify cellular service is activated. No calls can be made in this condition.

Limited Service

If there is a signal, but full service with the system is blocked, only emergency calls will be allowed. Contact your service provider for more information.

Network Registration

If the home network is unavailable, but there is another network available (either another frequency or system), the SX6P will attempt to register to that system. If there is more than one system, a list of available systems will display.

1. Use the arrow keys to highlight a network from the list.
2. Press the **SELECT** key. If the selected network cannot be accessed, the list of available networks will be updated and a different network must be selected.

CALL FUNCTIONS

Making Calls

1. Pick up the handset or press the **SPEAKERPHONE** key.
The SX6P is now "off-hook."
2. Listen for dial tone.
3. Dial the phone number. The dialed number will be displayed. The name will also be displayed if it is stored in the phonebook.

Correct Dialing Errors

- To erase one digit, press the **CLEAR** key once.
- To erase all digits, press and hold down the **CLEAR** key until all digits are erased.
- To insert numbers, use the arrow keys.

Redial the Last Telephone Number Dialed

1. Pick up the handset or press the **SPEAKERPHONE** key. The SX6P is now "off-hook."
2. Press the **REDIAL** key.

Receiving Calls

When there is an incoming call, the SX6P rings, an incoming call notification displays the call type and Caller ID information (if available).

1. Pick up the handset or press the **SPEAKERPHONE** key.
2. Begin talking.

NOTE: Press the **REJECT** key to refuse the call. The phone will stop ringing and the calling party will be disconnected.

Receive a Call When Caller ID is Activated

The Caller ID feature displays the caller's number when the SX6P rings. If the caller's name and number are stored together in the SX6P phonebook, the caller's name and number will be displayed. Contact your service provider to activate this feature.

NOTE: If there are missed calls (calls not answered), "MISSED CALLS" will be displayed with the number of calls missed. See the *Call Logs* section of this manual for more information.

Ending Calls

Hang up the phone by either placing the handset back onto the SX6P cradle or press the **SPEAKERPHONE** key if using the speakerphone.

In-Call Functions

Mute a Call

1. While in a call, press the **MUTE** key. A notification will display in the upper right corner of the LCD screen.
2. Press the **MUTE** key again to un-mute the microphone.

Place a Call on Hold

1. While in a call, press the **HOLD** key.
2. The display will change from Active to Held.
3. To reactivate the call, press the **HOLD** key again.

Adjust Volume

1. While in a call, press the **Volume** keys to raise or lower the handset/speakerphone volume.

SX6P BASIC FEATURES

Date and Time Settings

The SX6P allows customization of the date, time, time zone, and time format (12 or 24 hour).

Set the Date

1. Press the **MENU** key.
2. Select *Clock*.
3. Scroll to *Set Date*, then press the **CHANGE** key.
4. Enter the desired date.
5. Press the **OK** key.

Change the Date Format

1. Press the **MENU** key.
2. Select *Clock*, then select *Clock Settings*.
3. Scroll to *Date Format*. The current format will display.
4. Press the **CHANGE** key.
5. Select the desired date format.(D:M:Y, M:D:Y, or Y:M:D)
6. Press the **OK** key.

Set the Time

1. Press the **MENU** key.
2. Select *Clock*.
3. Select *Set Time*.
4. Enter the desired time.
5. Press the **OK** key.

Change the Time Format

1. Press the **MENU** key.
2. Select *Clock*, then select *Clock Settings*.
3. Scroll to *Time Format*. The current format will display.
4. Press the **CHANGE** key.
5. Select the desired time format (12 hour or 24 hour).
6. Press the **OK** key.

Set the Time Zone

1. Press the **MENU** key.
2. Select *Clock*, then scroll to *Set Time Zone*.
3. Press the **CHANGE** key. Use the two middle soft keys to scroll left or right on the graphic to highlight the time zone you are in.
4. Press the far left soft key to select the highlighted time zone.

Audio Settings

Adjust Alert Volume (Ringer)

1. Press the **MENU** key.
2. Select *Settings*, then select *Audio Settings*.
3. Select *Alert Volume*, then set the desired volume level using the arrow keys.

Adjust Alert Tones (Ringer)

Alert tones can be customized for different types of calls, such as voice or text.

1. Press the **MENU** key.
2. Select *Settings*, then select *Audio Settings*.
3. Use the arrow keys to scroll through the alert types.
4. Select the desired alert sound. (Voice call alert, SMS alert, Voicemail alert)

NOTE: If *No Alert* is selected, no alert will sound.

Turn On/Off the Keypad Tones

1. Press the **MENU** key.
2. Select *Settings*, then select *Audio Settings*.
3. Select *Keypad Tones*.
4. Select *On* or *Off*.

Turn On/Off the Warning Tones

1. Press the **MENU** key.
2. Select *Settings*, then select *Audio Settings*.
3. Select *Warning Tones*.
4. Select *On* or *Off*.

Speakerphone

1. Press the **SPEAKERPHONE** key. A dial tone will be heard through the speaker and the Speaker icon will display.
2. Enter a telephone number, press the **REDIAL** key or press the **NAME** key to find a number you have previously entered into the Phonebook - see the *Phonebook* section of this manual for details about how to enter a number.

Speakerphone Microphone Adjustment

You can adjust the microphone gain of the speakerphone from -5 to +5 using *Spkr Phone Adj* in the *Audio Settings* menu.

1. Press the **MENU** key.
2. Select *Settings* then *Audio Settings*.
3. Select *Spkr Phone Adj* then the desired microphone gain using the arrow keys.

Phonebook

The SX6P has an Internal Phonebook capable of storing up to 250 telephone numbers with corresponding names in the SIM card (SIM cards may have different memory capacities) and 18 in the phone memory.

HINT: To dial a number from the Phonebook when off hook, press the **NAME** key, select the name, then press the **DIAL** key.

NOTE: The Phonebook will not be accessible while the SIM Card is read when the SX6P is powered on. This process takes approximately 60 seconds.

Adjust Phonebook Settings

Entries can be saved to the SIM card or to the phone memory. When numbers are saved to the SIM card, they can be transferred by removing the SIM card and installing it in another GSM phone.

1. Press the **MENU** key.
2. Select *Phonebook*, then select *Settings*.
3. Select *Save Entries To*. (SIM card, Choice or Phone memory).
4. Select the desired location of the phonebook entries.

Keypad Buttons for Text Entry (Multitap)

There are three or four letters (as well as a number) assigned to each key on the telephone keypad. During text entry, pressing a key displays the first letter, then cycles through the other letters. For example, if the number 3 is pressed, a "D" will appear. If it is pressed again, the "E" will appear, and if it is pressed three times, the "F" will appear. The cursor will move on to the next space after a brief pause, so the letter must be selected quickly.

Enter a Hard Pause

Hard pauses allow the SX6P to be used with automated phone systems used for pagers or automated banking. When a number is programmed into the phonebook, a pause is entered by pressing and holding "#" for more than one second. The hard pause will be displayed as "P."

Use of Lower Case or Numbers

The "1" key can be used to switch change from upper case (ABC) to lower case (abc) or to numbers (123). The current setting will display under the clock in the upper right corner of the LCD screen.

Use Special Characters

The "1" key can access several special characters (punctuation marks and symbols). To scroll through available special characters, press the "1" key repeatedly.

Add a New Entry to the Phonebook

1. Press the **MENU** key.
2. Select *Phonebook*, then select *Add Name*.
3. Enter a name by pressing the alphanumeric keys (maximum 16 characters).
HINT: Use the "*" key to switch between upper case, lower case and numbers. Use the "0" key to insert a space between entries. Use the "1" key to access special characters. To correct errors in the name, press the **CLEAR** key.
4. Press the **OK** key.
5. Enter the desired telephone number (maximum of 20 digits).
6. Press the **OK** key. You will be prompted to enter another number.
7. Press the **OK** key to save the entry and return to the Phonebook menu. If you have additional numbers (up to 2 more) follow steps 5 through 7 for each number.

Phonebook Entry Search

1. Press the **NAME** key.
2. Use the arrow keys to scroll through the entries or use the keypad to view all entries that begin with a specific letter.
3. Press the **SELECT** key to view the phone number(s) listed for a highlighted entry.

Edit or Delete an Entry

1. Press the **NAME** key.
2. Use the arrow keys to scroll through the entries, or use the keypad to view all entries that begin with a specific letter.
3. Press the **SELECT** key to view the phone number(s) listed for an entry that is highlighted.
4. Press the **OPTIONS** key and select the desired option. (Edit Name, Edit Number, Add Number, Add Name, Add to Speed Dial, Delete Number or Delete Entry).

Speed Dialing

Speed dialing permits one-touch dialing for up to 10 telephone numbers stored in the phone book. 0 through 9 on the keypad are used for speed dialing. You must press and hold the corresponding key for 2 seconds to use speed dial.

Assign a Number to a Speed Dial Location

1. Press the **NAME** key.
2. Select the desired entry to add to the speed dial list.
3. Press the **OPTIONS** key.
4. Select *Add to Speed Dial*.
5. Use the arrow keys to scroll to a location, then press the **SELECT** key.

NOTE: If a location is already in use, the phone number that is stored there can be replaced with a new one.

Dial a Speed Dial Location

1. Pick up the handset or press the **SPEAKERPHONE** key.
2. Press and hold the number (for 2 seconds) of the location containing the speed dial number to be called.
3. The number is displayed and dials automatically.

View the Speed Dial List

1. Press the **MENU** key.
2. Select *Phonebook*, then select *Settings*.
3. Select *Speed Dial List*.

Change the Display Screen Contrast

1. Press the **MENU** key.
2. Select *Settings*, then select *Phone Settings*.
3. Select *Screen Contrast*.
4. Use the arrow keys to adjust the display contrast.
5. Press the **OK** key.

Change Backlight Options (SX6P-300G Series Only)

1. Press the **MENU** key.
2. Select *Settings*, then select *Phone Settings*.
3. Select *Backlight*, then choose the keypad lighting setting you prefer.
 - ON: Display and keypad are lit whenever phone is in use.
 - 15 Seconds: Display and keypad light when phone is in use, then go dark after 15 seconds.
 - Power Save: Display and keypad are never lit.

SX6P ADDITIONAL FEATURES

Call Logs

The SX6P stores the telephone numbers of the last ten outgoing calls and the last ten incoming calls with the dates and times of the calls. These numbers are displayed and can be dialed directly from the call log.

View the Call Log

1. Press the **MENU** key.
2. Select *Call Log*.
3. Select the desired calls to view (All, Missed, Received, Dialed). Calls are denoted by the following icons:

Dial a Number From the Call Log

1. Press the **MENU** key.
2. Select *Call Log*.
3. Highlight the desired call to dial.
4. Pick up the handset or press the **SPEAKERPHONE** key.
5. A dial tone will sound, then the number will be dialed.

NOTE: This feature will not work for unavailable or private calls (denoted as *Withheld* in the Log).

Clear the Call Log

1. Press the **MENU** key.
2. Select *Call Log*, then select *Clear Logs*.
3. Select *Yes* to clear the call log. Select *No* to return to the Call Log menu.

Check the Last Call Time

1. Press the **MENU** key.
2. Select *Call Log*, then select *Call Time*.
3. Select *Last Call Time*.

Check Total Accumulated Air Time

1. Press the **MENU** key.
2. Select *Call Log*, then select *Call Time*.
3. Select *All Calls Time*.

GPRS Call Information

1. Press the **MENU** key.
2. Select *Call Logs* then *GPRS Info*.

Alarm Settings

The SX6P alarm feature can be used as an alarm clock. Alarm time and tone can be set for daily use or for one time only.

Set Alarm Time and Tone

1. Press the **MENU** key.
2. Select *Clock*, then select *Set Alarm*.
3. Select *Set Time*, then enter the desired alarm time.
4. Press the **OK** key.
5. Select *Set Tone*, then select the desired alarm tone.
6. Press the **OK** key.
5. Press the **OK** key.

Set Alarm to Repeat Daily

1. Press the **MENU** key.
2. Select *Clock*, then select *Set Alarm*.
3. Select *Repeat Daily*.

Turn Alarm On/Off

1. Press the **MENU** key.
2. Select *Clock*, then select *Set Alarm*.
3. Select *Alarm Status*.
4. Select *On* or *Off*.
5. Press the **OK** key.

Language Selection

The SX6P is capable of displaying menu items in several different languages.

Select a Language

1. Press the **(MENU)** key.
2. Select *Settings*.
3. Select *Phone Settings*.
4. Select *Set Language*.
5. Scroll through the list of desired languages.
6. Highlight the desired language, then press the **SELECT** key.

Personalization Options

The SX6P can be customized with a personal greeting that displays when the SX6P is turned on. It can also be programmed to display your phone number.

Store Your Telephone Number for Viewing

1. Press the **MENU** key.
2. Select *Settings*, then select *Phone Settings*.
3. Select *My Number*.
4. Press the **EDIT** key.
5. Enter your phone number.
6. Press the **OK** key.

NOTE: To display your phone number, follow steps 1-3 above.

Change Greeting Message

1. Press the **MENU** key.
2. Select *Settings*, then select *Phone Settings*.
3. Select *Set Greeting*.
4. Enter the desired greeting message.
5. Use the arrow keys to change the delay time (2-20 seconds).
6. Press the **OK** key.

HINT: Use the “*” key to switch between upper case, lower case and numbers. Use the “0” key to insert space between words/names. Use the “1” key to access special characters.

Call Settings

Minute Minder

When turned on, the Minute Minder emits a low audible tone once every minute while a call is active.

1. Press the **MENU** key.
2. Select *Settings*, then select *Call Settings*.
3. Select *Minute Minder*, then select *On* or *Off* as desired.

Call Timer

When turned on, the Call Timer displays during an active call. It can be set to remain visible for 30 seconds after the call is terminated or until another action (key press or taking SX6P off-hook).

1. Press the **MENU** key.
2. Select *Settings*, then select *Call Settings*.
3. Select *Call Timer*, then select the desired option. Options include:
 - *Off* - no call timer displayed.
 - *On For 30 Sec.* - call timer is displayed for 30 seconds or until user action.
 - *On Until Action* - call timer is displayed until a user action.

Dial Delay

The Dial Delay is the amount of time, after a digit is dialed, the SX6P waits before automatically sending the call.

1. Press the **MENU** key.
2. Select *Settings*, then select *Dial Settings*.
3. Select *Dial Delay*.
4. Use the arrow keys to change the delay time(2 - 20 seconds).
5. Press the **OK** key.

Auto Dial

The SX6P is able to recognize frequently called numbers and automatically dial them without waiting for the Dial Delay. Once a number has been called twice successfully, it will Auto Dial when this option is turned on.

1. Press the **MENU** key.
2. Select *Settings*, then select *Dial Settings*.
3. Select *Auto Dial*.
4. Select *On* to enable Auto Dial.

Network Settings

Network settings allow selection of a desired network and addition of a network operator to the network list.

Automatic Selection

This option allows the SX6P to select the network automatically, based on the SIM Card account information.

Manual Selection

This allows you to see a list of networks in your area. Select the desired network from the list and the SX6P will attempt to use that network.

1. Press the **MENU** key.
2. Select *Settings*, then select *Network Settings*.
3. Select *Select Network*.
4. Select either *Automatic* or *Manual*.

Set the Preferred Network

This option allows networks to be added to the preferred list of networks. Networks on this list will be selected first when the SX6P searches for a network.

NOTE: There may be several networks on the list.

Insert New Entry

1. Press the **MENU** key.
2. Select *Settings*, then select *Network Settings*.
3. Select *Select Network*.
4. Select *Set Preferred*.
5. Highlight the entry above which the new preferred carrier is to be inserted.
6. Press the **SELECT** key.
7. Select *Insert*.
8. Select an entry from the list.

Delete Entry

1. Press the **MENU** key.
2. Select *Settings*, then select *Network Settings*.
3. Select *Select Network*.
4. Select *Set Preferred*.
5. Select the desired entry to delete.
6. Select *Delete*.

Add New Network

If a known network is not on the list, it can be added. The Country Code, Network Code, and Network Name must be provided in order to add a network to the list. Once added to the network list, the network can be accessed via the Set Preferred Network option.

1. Press the **MENU** key.
2. Select *Settings*, then select *Network Settings*.
3. Select *Select Network*.
4. Select *Add New Network*.
5. Press the **SELECT** key.
6. Select *Add*.
7. Enter the correct Country Code, Network Code, and Network Name as prompted.

Edit or Delete an Added Network

Network information can be edited or deleted.

1. Press the **MENU** key.
2. Select *Settings*, then select *Network Settings*.
3. Select *Select Network*.
4. Select *Add New Network*.
5. Select the network to be edited or deleted.
6. Select *Change* to edit the network information. Select *Delete* to delete the network from the list.

Change Network Password (Network Dependent)

The network password assigned by your service provider can be changed. However, this option may not be available from all network providers.

1. Press the **MENU** key.
2. Select *Settings*, then select *Network Settings*.
3. Select *Change Network Password*.
4. Change your password per your network provider's instructions.

SIM PIN Setup

SIM PIN1 controls access to SIM Card information. When SIM PIN1 is on, it must be entered each time the SX6P is turned on. Another user can still access the phone with a different SIM Card. SIM PIN2 accesses network-controlled features.

NOTE: Contact your network provider for information related to SIM PINs.

Turn On/Off SIM PIN1

1. Press the **MENU** key.
2. Select *Settings*, then select *Security Settings*.
3. Select *SIM PIN1*.
4. Select *On* or *Off*.

Automatic SIM PIN Entry

When SIM PIN1 is enabled, you must enter PIN1 every time the SX6P is powered on. To bypass this entry but keep the PIN active, simply enable **Auto PIN Entry**. This allows the SX6P to remember the correct PIN the first time entered. The PIN will then be automatically entered at any future power on. This allows a measure of security where the SIM cannot be used in another device without knowing the PIN.

1. Press the **MENU** key.
2. Select *Settings* then *Security Settings*.
3. Select *Auto PIN Entry* then *On* or *Off*.

NOTE: When SIM PIN1 is disabled, this setting has no effect.

Change SIM PIN1

SIM PIN1 must be enabled and a valid PIN must be entered before this menu item will appear.

1. Press the **MENU** key.
2. Select *Settings*, then select *Security Settings*.
3. Select *SIM PIN1*.
4. Select *Change PIN*.
5. Enter the old PIN, then press the **OK** key.
6. Enter the new PIN, then press the **OK** key.
7. Enter the new PIN again, then press the **OK** key.

NOTE: The PIN must be between 4 and 8 digits. Press the **CLEAR** key to make changes.

Change SIM PIN2

1. Press the **MENU** key.
2. Select *Settings*, then select *Security Settings*.
3. Select *SIM PIN2*.
4. Select *Change PIN*.
5. Enter the old PIN, then press the **OK** key.
6. Enter the new PIN. It must be numerical and between 4 and 8 digits long.
7. Press the **OK** key to save the new PIN, or use the **CLEAR** key to make changes.

Handset Call Barring (Requires 4 digit code to make changes).

Use of the SX6P can be restricted by barring certain types of calls from being made or received.

Bar All Incoming Calls

1. Press the **MENU** key.
2. Select *Settings*, then select *Security Settings*.
3. Select *Handset Call Barring*.
4. Select *Bar Incoming*, then select *On*. Select *Off* to cancel the bar.

Bar All Outgoing Calls

1. Press the **MENU** key.
2. Select *Settings*, then select *Security Settings*.
3. Select *Handset Call Barring*.
4. Select *Bar Outgoing*, then select *All*. Select *Off* to cancel the bar.

Bar Outgoing Calls to Specific Prefixes (No Prefixes Set)

You can restrict outgoing calls based on prefixes or numbers that are part of a full phone number. For example, to restrict all outgoing calls made with 847 as the first 3 digits, enter 847 as the prefix. A maximum of 11 digits can be entered.

1. Press the **MENU** key.
2. Select *Settings*, then select *Security Settings*.
3. Select *Handset Call Barring*.
4. Select *Bar Outgoing*, then select *List*.
5. Since no prefixes have been set, *List Empty* will be displayed. Select **OK**, then select *Add*.
6. Enter the prefix you want barred, then press the **OK** key.
7. You can now *Add*, *Edit*, *Delete*, or *Clear All* prefixes by pressing the **OPTIONS** key.

Bar Outgoing Calls to Specific Prefixes (Prefixes Set)

1. Press the **MENU** key.
2. Select *Settings*, then select *Security Settings*.
3. Select *Handset Call Barring*.
4. Select *Bar Outgoing*, then select *List*.
5. The list of prefixes you have already set will be shown. You can now add a new prefix, edit or delete a selected prefix, or clear all prefixes by pressing **OPTIONS**.

Add Additional Prefixes

1. Press the **OPTIONS** key, then select *Add*.
2. Enter the new prefix, then press the **OK** key.

Edit Current Prefixes

1. Press the **OPTIONS** key, then select *Edit*.
2. Use the arrow and **CLEAR** keys to edit the prefix.
3. Press the **OK** key when finished.

Delete Prefixes

1. Press the **OPTIONS** key, then select *Delete*.
2. Press the **OK** key to delete the prefix.

NOTE: Press the **BACK** key to go back to the previous menu.

Clear All Prefixes

1. Press the **OPTIONS** key, then select *Clear All*.
2. Press the **OK** key to remove all prefixes.

NOTE: Press the **BACK** key to go back to the previous menu.

Restricted Dialing

Outgoing calls can be restricted by creating a Fixed Dialing list that allows only numbers on that list to be dialed from the SX6P.

Add to the Fixed Dialing List

1. Press the **MENU** key.
2. Select *Settings*, then select *Security Settings*.
3. Select *Fixed Dialing*.
4. Select *Edit Dial List*.
5. Enter *SIM PIN 2*, then press the **OK** key.
6. To add a new entry, select *Add*, enter the new number, then press the **OK** key.

Edit the Fixed Dialing List

1. Press the **MENU** key.
2. Select *Settings*, then select *Security Settings*.
3. Select *Fixed Dialing*.
4. Select *Edit Dial List*.
5. Enter *SIM PIN 2*, then press the **OK** key.
6. Use the arrow keys to highlight the desired entry to edit.
7. Press the **OPTIONS** key.
8. Select *Edit* to change the entry. Select *Delete* to erase the entry.

Activate Fixed Dialing

1. Press the **MENU** key.
2. Select *Settings*, then select *Security Settings*.
3. Select *Fixed Dialing*.
4. Select *On*.
5. Enter *SIM PIN 2*, then press the **OK** key.

Deskphone Lock

Access to the SX6P menu options can be restricted by locking the phone. When the deskphone is locked, a PIN is required to make any calls or access any menu items. Incoming calls can still be received. When the SX6P is locked, press the **UNLOCK** key, then enter the PIN to unlock it.

Lock the SX6P

1. Press the **MENU** key.
2. Select *Settings*, then select *Security Settings*.
3. Select *Deskphone Lock*, then select *On*.
4. Enter the PIN (default pin is 1234).

Change Deskphone Lock PIN

1. Press the **MENU** key.
2. Select *Settings*, then select *Security Settings*.
3. Select *Deskphone Lock*, then select Change PIN.
4. Enter the old PIN, then press the **OK** key.
5. Enter the new PIN, then press the **OK** key.

Closed User Groups (CUG)

This feature depends entirely on your service provider and your account subscription. Contact your service provider for more information.

CUG Settings

1. Press the **MENU** key.
2. Select *Settings* then *Security Settings*.
3. Select *CUG Settings*.

Edit a CUG

1. Press the **MENU** key.
2. Select *Settings* then *Security Settings*.
3. Select *CUG Settings* then select *List CUGs*
4. Press **Edit** to edit the CUGs.

Select a CUG

1. Press the **MENU** key.
2. Select *Settings* then *Security Settings*.
3. Select *CUG Settings* then select *Select*
4. Press **Select** on a highlighted CUG.

Restore Factory Defaults

All system features can be reset to the factory defaults.

1. Press the **MENU** key.
2. Select *Settings*, then select *Restore Defaults*.
3. Select **Yes** to restore all factory default settings.

SUPPLEMENTARY SERVICES (NETWORK DEPENDENT)

In-Call Options

The following options are available during a call. While in a call, press the **MENU** key to access these options. Options display based on call status. For example, Retrieve will only display if a call is on hold or if Call Waiting indicates a second incoming call.

Hold: Puts active call on hold.

Retrieve: Activates a call that is on hold.

Swap: Swaps between held call and active call.

End Current: Ends the current call.

Multiparty: Displays options for managing multiparty calls.

Main Menu: Allows access to the Phonebook, Messages, or Call Log features.

Call Divert (Forwarding)

Call Divert sends incoming calls to another telephone number, even when the SX6P is turned off. Call Divert options include all calls, calls that come in when the line is busy, calls that are not answered after a specified number of seconds, or calls that come in when the SX6P is powered off or has lost the network signal (*Not Found*). Certain types of calls can be diverted, such as voice, data, fax, or text messages. Contact your service provider to activate the Call Divert feature.

Turn On Call Divert

1. Press the **MENU** key.
2. Select *Call Divert*.
3. Select the desired divert type (*All Calls, When Busy, No Answer, Not Found*).
4. Select *On* to divert all types of calls. To specify which types of calls to divert, select *By Service*, highlight the desired service to divert, then press the **SELECT** key.
5. Enter the number to which calls will be diverted, then press the **OK** key.

HINT: Pressing the **OK** key before entering a number will display the Phonebook. Select a number, then press the **OK** key.

Turn Off Call Divert

1. Press the **MENU** key.
2. Select *Call Divert*.
3. Select the desired divert type (*All Calls, When Busy, No Answer, Not Found*).
4. Select *Off*.

Cancel All Diverts

1. Press the **MENU** key.
2. Select *Call Divert* then *Cancel All Diverts*.

NOTE: When selected, all diverts will be canceled by the network.

Call Waiting

Call Waiting enables notification of incoming calls when the SX6P is off-hook (whether during a call or during dialing). To respond to Call Waiting, press the **FLASH** key or the hook switch. Contact your service provider to activate Call Waiting.

Enable/Disable Call Waiting

1. Press the **MENU** key, then select *Settings*.
2. Select *Call Settings*, then select *Call Waiting*.
3. Select *On* to enable. Select *Off* to disable.

Multiparty Calling

Multiparty Calling allows connection to several calls simultaneously. Contact your service provider to activate Multiparty Calling.

Engage a Multiparty Call

1. While in a call, put the call on hold (via the **HOLD** key).
2. Dial a second number, then press the **FLASH** key to connect it.
3. When the second call is answered, press the **MENU** key and then select *Multiparty*.
4. Select the desired option.

Join All: Join the active call with the held multiparty call.

Hold All: Place multiparty call on hold.

Next: Display the next call party in a multiparty call.

Transfer: Connect one call party to another call party and allow the user to leave the call.

Exclude: Place the selected party of a multiparty call on hold.

Private: Hold a private call with one party in a multiparty call. Other parties are put on hold.

I am busy: User defined user busy (UDUB) indicates BUSY to a waiting caller.

End All: End active and held calls.

NOTE: Options available depend on the status of the call or calls. For example, if only one other person is in the call, only the End All option will display, or if all the calls have been joined, the Join All option will not display.

Caller ID Settings

Caller ID settings allow personalization of how caller's information is presented and how your information is presented when you call someone who has caller ID capability. Options include Show caller's ID, show caller's number, hide your ID (hides only your name information), show called ID, hide ID if called.

1. Press the **MENU** key.
2. Select *Settings*, then select *Call Settings*.
3. Select *Caller ID*, then select the desired option.

Blocking Your Number (CLIR)

To hide your number when calling others enter # 31 # before you dial the phone number. For example, to block your phone number from appearing on 847 555 1212, simply dial # 31 # 847 555 1212. This feature is network dependent. Check with your carrier for more information.

Voicemail

The **VM** key will blink and the envelope icon will display when there are new voicemail messages. Contact your service provider to activate voicemail and for voicemail settings.

Set Voicemail Access Numbers

Typically, your service provider will set the voicemail access numbers for you. If they do not, contact them for the Home Mailbox , Roam Mailbox, Voice, and Message numbers.

1. Press the **MENU** key.
2. Select *Messages*, then select *Voicemail*.
3. Select *Voicemail Settings*, then select *Box Numbers*.
4. Select *Home Mailbox*, then enter the number provided by your service provider.
5. Press the **OK** key.
6. Follow steps 4 and 5 for the Roam Mailbox.

SMS Alert Match

Your network provider may send a text message (SMS) to alert you when you have voicemail. If configured, the SX6P can match this message to let you know that you have voicemail instead of just another text message.

1. Press the **MENU** key, then select *Messages*.
2. Select *Voicemail*, then *Voicemail Settings*, then *Alert Match*.
3. Enter part of the text you receive when the network sends you an SMS message for voicemail. You do not have to enter the whole message just part of the message.
4. When complete, press the **OK** key.

Check Voicemail

1. Press the **VM** key. You will be connected to your voicemail system automatically.
2. Follow the automated instructions.

Short Message Service (SMS)

The SX6P is capable of sending and receiving SMS text messages. Each SMS message can have a maximum of 160 characters. Upon receipt of a new SMS message, the message icon (envelope) will be displayed and the **SMS** key will blink. A maximum of 10 messages can be stored. Contact your service provider to activate SMS.

SMS messages can be generated using the SX6P keypad.

Read Received Text Messages

1. Press the **SMS** key.
2. Select *Received Messages*.
3. Scroll to the desired message.
4. Press the **READ** key.

NOTE: Unread messages are denoted by a closed envelope icon.

Reply to Received Messages

1. View the desired message.
2. Press the **OPTIONS** key.
3. Select *Text Reply* to reply with a text message. Select *Voice Reply* to reply with a voicemail.
4. For a text reply, type a reply message, then press the **OK** key. Selecting *Voice Reply* will activate the speakerphone and call the person who sent the message.

Forward Text Messages

1. View the desired message.
2. Press the **OPTIONS** key, then select *Forward*.
3. Enter the desired number or press the **NAME** key to select a phonebook entry.
4. Press the **OK** key.
5. To send the message, select *Send Now*. To save the message to send at a later time, select *Send Later*.

Delete Text Messages

1. View the desired message.
2. Press the **OPTIONS** key.
3. Select *Delete*.

Create Text Messages

1. Press the **SMS** key.
2. Select *Create Message*.
3. Enter the message text.

NOTE: Use the “*” key on the keypad to change the type of text (all capital letters - ABC, lower case letters - abc, or numbers -123). The current text type is displayed under the clock in the upper right corner of the display screen. Use the “0” to insert spaces between words. Use the “1” key to access special characters.

4. Press the **OK** key.
5. Enter the desired number, or press the **NAME** key to select a phonebook entry.
6. Press the **OK** key.
7. To send the message, select *Send Now*. To save the message to send at a later time, select *Send Later*.

View Saved Messages

1. Press the **SMS** key.
2. Select *Saved Messages*.
3. Select the desired message.

Send Saved Messages

1. Press the **SMS** key.
2. Select *Saved Messages*.
3. View the desired message.
4. Press the **OPTIONS** key.
5. Select *Forward*.
6. Enter the desired number or press the **NAME** key to select a phonebook entry.
7. Press the **OK** key.
8. To send the message, select *Send Now*. To save the message to send at a later time, select *Send Later*.

Message Settings

Message Center

The message center number is used to retrieve your text messages. Contact your service provider for this number.

1. Press the **SMS** key, then select *Message Settings*.
2. Select *Message Center*, then enter the number that your service provider gave you.

NOTE: If the number is already entered, press the **OK** key.

3. Press the **OK** key.

Message Lifetime

Message lifetime is the amount of time that an unread message will remain on the network server before being removed.

1. Press the **SMS** key.
2. Select *Message Settings*.
3. Select *Message Lifetime*.
4. Select the desired time for unread messages to remain on the network server.
5. Press the **OK** key.

Message Format

This allows messages to be sent in different formats. Contact your service provider for information about which message formats are supported.

1. Press the **SMS** key.
2. Select *Message Settings*.
3. Select *Message Format*.
4. Select the desired message format.
5. Press the **OK** key.

Information Messages

Information messages provide information such as phone numbers for taxi services, car rentals, or emergency services. If your service provider offers information messages, you can select the subjects to view and the language in which to view them. Contact your service provider for more information.

Set Information Subjects

1. Press the **MENU** key.
2. Select *Messages*, then select *Info messages*.
3. Select *Settings*, then select *Subject*.
4. Select *Active*.
5. Press the **SELECT** key.
6. Select *Add*.
7. Select the desired subject from the list.

Set Languages

1. Press the **MENU** key.
2. Select *Messages*, then select *Info messages*.
3. Select *Settings*, then select *Set Languages*.
4. Select the desired language from the list.

Network Call Barring

The SX6P supports network call barring of incoming or outgoing calls and allows barring of specific types of services, such as voice or data. Contact your service provider to activate network call barring.

The following call barring options are available:

- **Foreign Calls:** Does not allow international calls.
- **Only local and home country:** Only allows local and home country calls.
- **Bar Incoming:** Does not allow any incoming calls.
- **Bar Incoming if Abroad:** Does not allow any incoming calls when the SX6P is outside the home network country.
- **Bar Outgoing:** Does not allow any calls to be made.
- **Bar All:** Does not allow any calls to be made or received.
- **Cancel All:** Deactivates any network call bars that are currently active.

Activate Call Bars

1. Press the **MENU** key.
2. Select *Settings*, then select *Security Settings*.
3. Select *Network Call Barring*.
4. Select the desired type of network call bar to activate (see list above for descriptions of each type).
5. Select the desired service to bar.
6. Select *On*.
7. Enter the network password, then press the **OK** key.

Deactivate Call Bars

1. Press the **MENU** key.
2. Select *Settings*, then select *Security Settings*.
3. Select *Network Call Barring*.
4. Select the desired type of network call bar to deactivate.
5. Select the desired service to deactivate.
6. Select *Off*.
7. Enter the network password, then press the **OK** key.

Check Call Bar Status

To see which call bar options are active or inactive:

1. Press the **MENU** key.
2. Select *Settings*, then select *Security Settings*.
3. Select *Network Call Barring*.
4. Select the desired type of network call bar to check.
5. Select the desired service, then select *Status*. The current setting will be displayed.

DATA FEATURES (SX6P-300G series only)

When connected to a personal computer (PC), the SX6P is capable of sending and receiving digital fax and data, sending and receiving email communications, and accessing the Internet. Data speeds may vary depending upon your cellular network.

Connect SX6P to a Computer

Use a RS232 serial cable to connect the DB-9 data port on the SX6P to the appropriate data port on your PC.

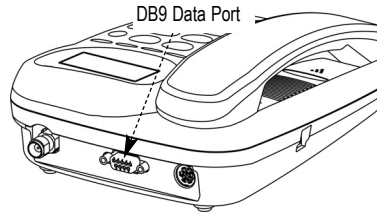

Figure 18 - DB9 Data Port on the SX6P

Configure PC for Circuit Switched Data

Requirements

- Active GSM account with your network service provider including a Data/Fax facility
- Windows (version 2000 or later)
- PC with a COM Port.

NOTE: When all of the above have been satisfied, you may proceed.

Modem Setup

1. Power on your PC/laptop.
2. Access the Control Panel, then select the Modems option.
3. Install a new modem device for the SX6P with the following specifications:

Modem Type: Standard 19200 bps Modem

Maximum speed of serial port: 19,200

Data bits: 8

Parity: None

Stop bits: 1

Use Flow Control: Enable this option and select Hardware [RTS/CTS]

Extra settings: AT & D1

Automatic Baud Rate Fall Back Control

The SX6P supports an automatic fallback to 19,200 bps when errors are detected in the data stream. This is useful for applications such as PC digital fax because most PC fax applications require a 19,200 bps baud rate on the serial port.

Enabling Fallback

Enable this feature when you have an application that uses a port speed of 19,200 bps. When the SX6P has a port speed that does not match the port speed on the PC, errors will be detected. When these errors are detected, the SX6P will adjust the port speed to 19,200 bps, thus matching the PC application rate of 19,200 bps. It does not matter if the SX6P's port speed is higher or lower than 19,200 bps, the SX6P will still adjust the rate to 19,200 bps.

NOTE: The SX6P does not support autobauding and will only adjust the port speed to 19,200 bps under the above conditions. No other rate will be automatically set.

1. Press the **MENU** key.
2. Select *Settings* then *Data Settings*.
3. Select *DTE Fallback* then *On*. (**This is the factory default setting**)

When to Disable Fallback

If you mainly use the SX6P for GPRS data, then **disable** fallback of the port rate. This will allow some errors in the data stream without effecting a change in port speed on the SX6P.

1. Press the **MENU** key.
2. Select *Settings* then *Data Settings*.
3. Select *DTE Fallback* then *Off*.

Baud Rate AT Commands

The SX6P will accept AT commands to setup the port speed. If you want to change the SX6P port speed for a session or keep the change permanent, or if you just want to see the profile settings, use the following AT commands from a terminal application (like HyperTerminal).

NOTE: Make sure DTE Fallback is **OFF** before making changes to the baud rate.

| | |
|---|--------------------|
| View current configuration | AT&V |
| Change the port speed on the SX6P to <baud rate> | AT+IPR=<baud rate> |
| Permanently change the SX6P port speed to <baud rate> | AT+IPR=<baud rate> |

Digital Fax Setup

The SX6P is capable of receiving and sending faxes via a personal computer using a standard RS232 serial port. The PC application and modem setup must be able to support software flow control. To setup flow control properly, follow the instructions for setting up a standard modem connection in Appendix A of this manual with the following changes.

HINT: Setup a separate modem for PC fax and a separate modem for PC circuit switched data connections. This way you will not have to make changes to the modem settings every time you want to use fax or data.

1. Change the flow control of the standard modem to enable **software flow control**.
2. Change Extra Settings from AT&D1 to **AT+IFC=1,1 &d1**. This enables software flow control on the SX6P.
3. On the SX6P, select the serial port for your data connections by entering the **MENU**, then select *Settings*, then *Fax Port*, then *Data Port*, and then *Serial Port* (DB9).
4. Run your PC fax application using this new modem connection for receiving and sending faxes.

GPRS (Packet Data) Connections

The SX6P will allow GPRS connectivity if your network service provider has this feature available. GPRS allows packet data connections at higher speeds than conventional circuit switched (dial-up) connections. A GPRS Kit can be used when you are connecting with GPRS service. This kit contains a serial cable and a setup CD for installation on a standard personal computer. Contact your service provider or nearest dealer for more information.

SX6P TROUBLESHOOTING

Telephone Service is Not Working (Cannot make or receive calls)

- Make sure the SX6P is powered on properly.
- Make sure any equipment that is externally connected to the SX6P is correctly connected.
- Test any externally connected equipment on a known system to verify operation.
- Make sure the antenna is properly connected.
- Make sure your account with your service provider is activated and that service is established.

Unable to Receive Calls

- Is the handset on the cradle? If not, place the handset on the cradle and try again.
- Is the SX6P making a loud, repetitive tone? Then either the speakerphone or the handset is off hook. Hang-up and try again.

Unable to Make Calls

- If you do not hear standard dial tone when off hook, then your service has a problem. Contact your service provider if you think this is the problem.

Unable to Send or Receive Circuit Switched Data (CSD) Calls

- Is your computer connected to the serial port of the SX6P? If not, connect the computer with an appropriate RS232 / DB-9 cable.
- Do you have CSD service on your wireless account? Contact your service provider for information.
- Is your computer configured properly to access data service with the SX6P? Please reference the data sections of this manual for proper setup.

Unable to Connect to GPRS Service

- Is your computer connected to the serial port of the SX6P? If not, connect the computer with an appropriate RS232 / DB-9 cable.
- Do you have GPRS service on your account? Contact your service provider for information.
- Is your computer configured properly to access GPRS with the SX6P? Please reference the data sections of this manual for proper setup or your GPRS setup wizard help file for more information.
- You cannot pass the dialing sequence of the connection. Make sure that DTE Fallback is disabled. See the data section of the manual for more information.
- You can dial the connection but cannot authenticate with the network. There may be a network or account setup problem. Contact your service provider for more information.

Moisture or Ventilation Problems

- Is moisture forming on or around the SX6P? Remove any moisture with a clean dry towel and move the unit to a well ventilated area. Review the Temperature and Environment section of this manual for more information.

No Power

- Is the power supply connected to the unit? Make sure power is available and that the power supply is properly connected to the SX6P.
- The power supply is connected but the unit still has no power. Make sure the circuit is functioning to the power supply. Check breakers & contact your power company. Power may be off at location.

CONFORMANCE STATEMENTS



The SX6P 850/1900 Mhz models are in conformance with all applicable FCC requirements.

FCC Part 15 Class B Compliance

This Phonecell® SX6P model has been tested and found to comply with the limits for a Class B digital device, pursuant to Part 15 of the FCC rules. Changes or modifications not expressly approved by Telular Corporation will void your authority to operate the equipment per FCC part 15 paragraph 15.21. These limits are designed to provide reasonable protection against harmful interference in a residential installation. This equipment generates, uses and can radiate radio frequency energy and, if not installed and used in accordance with the instructions, may cause harmful interference to radio communications. However, there is no guarantee that interference will not occur in a particular installation. If this equipment does cause harmful interference to radio or television reception, which can be determined by turning the equipment OFF and ON, the user is encouraged to try to correct the interference by one or more of the following measures:

- Reorient or relocate the antenna.
- Increase the separation between the equipment and the terminal.
- Connect the equipment into an outlet on a circuit different from that to which the terminal is connected.
- Consult your Authorized Telular Distributor or an experienced radio/TV technician for help.

SAFETY INFORMATION

The Phonecell® SX6P functions as both a radio transmitter and receiver. When it is ON, the SX6P receives and sends out radio frequency (RF) energy. The SX6P GSM 900/1800 unit operates in the frequency ranges of 890 MHz to 960 MHz and 1710 MHz to 1880 MHz. The SX6P 1900 unit operates in the frequency range of 1850 MHz to 1990 MHz. Both units employ commonly used phase/frequency modulation techniques. When you use the SX6P, the cellular system handling your call controls the power level at which the unit transmits.

Exposure to RF (Radio Frequency) Energy

In 1991, the Institute of Electrical and Electronics Engineers (IEEE), and in 1992, the American National Standards Institute (ANSI), updated the 1982 ANSI Standard for safety levels with respect to human exposure to RF energy. After reviewing the available body of research, more than 120 scientists, engineers and physicians from universities, government health agencies and industry developed this updated Standard. In March, 1993, the U.S. Federal Communications Commission (FCC) proposed the adoption of this updated Standard.

The design of your Telular Phonecell® SX6P complies with this updated Standard. Of course, if you want to limit RF exposure even further than the updated ANSI Standard, you may choose to control the duration of your calls and operate your phone in the most power-efficient manner.

Safe Operation Requirement

The Phonecell® SX6P must be either wall mounted or desk mounted and should not be operated when any person is within 203 mm (8 inches) of the antenna.

Temperature Environment

Operating Temperature: From -10°C to +50°C ; Up to 95% relative humidity (non-condensing).

Storage Temperature: From -40°C to +60°C; Up to 95% relative humidity (non-condensing).

Antenna Care and Replacement

Do not use the Phonecell® SX6P with a damaged antenna. If a damaged antenna comes into contact with the skin, a minor burn may result. Have your antenna replaced by a qualified technician immediately. Use only a manufacturer-approved antenna. Unauthorized antennas, modifications, or attachments could damage the Phonecell® SX6P.



WARNING!

DO NOT PICK UP OR CARRY THE PHONE BY ITS ANTENNA. THIS ACTION MAY CAUSE SERIOUS DAMAGE.

Driving

Check the laws and regulations on the use of cellular products in the areas where you drive. Some jurisdictions prohibit your using a cellular device while driving a vehicle. Even if your jurisdiction does not have such a law, we strongly suggest that, for safety reasons, the driver use extreme caution when operating the cellular device while the vehicle is in motion. Always obey the law.

Electronic Devices

Most modern electronic equipment is shielded from RF energy. However, RF energy from cellular devices may affect inadequately shielded electronic equipment.

RF energy may affect improperly installed or inadequately shielded electronic operating and entertainment systems in motor vehicles. Check with the manufacturer or its representative to determine if these systems are adequately shielded from external RF energy. You should also check with the manufacturer of any equipment that has been added to your vehicle.

Consult the manufacturer of any personal medical devices (such as pacemakers, hearing aids, etc.) to determine if they are adequately shielded from external RF energy.

Turn your Phonecell® SX6P OFF in health care facilities when any regulations posted in the areas instruct you to do so. Hospitals or health care facilities may be using equipment that could be sensitive to external RF energy.

Aircraft

Turn OFF your Phonecell® SX6P before boarding any aircraft.

- Use it on the ground only with crew permission.
- Do not use it in the air.

To prevent possible interference with aircraft systems, U.S. Federal Aviation Administration (FAA) regulations require you to have permission from a crew member to use your cellular phone (or any other cellular product) while the plane is on the ground. To prevent interference with aircraft systems, FCC regulations prohibit using your cellular device while the plane is in the air.

Children

Do not allow children to play with your Phonecell® SX6P to prevent damage to the unit.

Blasting Areas

Construction crews often use remote control RF devices to set off explosives. Therefore, to avoid interfering with blasting operations, turn your Phonecell® SX6P OFF when in a "blasting area" or in areas posted: "Turn off two-way radio."

Potentially Explosive Atmospheres

Turn your Phonecell® SX6P OFF when in any area with a potentially explosive atmosphere. It is rare, but your Phonecell® SX6P or its accessories could generate sparks. Sparks in such areas could cause an explosion or fire resulting in bodily injury or even death.

Areas with a potentially explosive atmosphere are often, but not always, clearly marked. They include fueling areas such as gas stations; below deck on boats; fuel or chemical transfer or storage facilities; areas where the air contains chemicals or particles, such as grain, dust, or metal powders; and any other area where you would normally be advised to turn off your vehicle engine.

Do not transport or store flammable gas, liquid or explosives in the area of your Phonecell® SX6P or accessories.

Vehicles using liquefied petroleum gas (such as propane or butane) must comply with the National Fire Protection Standard (FPA-58). For a copy of this standard, contact the National Fire Protection Association, One Batterymarch Park, Quincy, MA 02269, Attn: Publications Sales Division.

WARRANTY

I. WHAT THIS WARRANTY COVERS AND FOR HOW LONG:

TELULAR CORPORATION ("Telular") warrants to a distributor Buyer, or to a customer only if the customer is a Buyer directly from Telular, that the Products (including accessories) shall comply with the applicable Specifications and shall be free from defects in material and workmanship under normal use and service for a period of fifteen (15) months from date of shipment from Telular. Telular, at its option, shall at no charge either repair, replace or refund the purchase price of the Product during the warranty period, provided it is returned by Buyer in accordance with the terms of this warranty to the Telular designated repair center. Repair or replacement, at Telular's option, may include the replacement of parts, boards or Products with functionally equivalent reconditioned items. Repaired and replacement items are warranted for the balance of the original warranty period. All replaced items shall become the property of Telular. **SUCH ACTION ON THE PART OF TELULAR SHALL BE THE FULL EXTENT OF TELULAR'S LIABILITY HERE-UNDER, AND BUYERS EXCLUSIVE REMEDY.** Buyer shall be responsible for all costs and expenses incurred by Buyer including without limitation any handling, labor or transportation charges. **OTHER THAN AFORESAID, THIS EXPRESS WARRANTY IS EXTENDED BY TELULAR TO BUYER ONLY AND NOT TO BUYER'S CUSTOMERS OR USERS OF BUYER'S PRODUCTS.**

II. HOW TO OBTAIN WARRANTY SERVICE

Product covered under this warranty shall only be accepted from and returned to Buyer's designated repair center. Buyer's dealers, distributors, agents, and end users cannot submit items to Telular under this warranty. To receive warranty service an RMA number must first be obtained from Telular Technical Support. The defective or non-compliant Product should be sent by Buyer freight pre-paid to: Telular Corporation, 647 North Lakeview Parkway, Vernon Hills, IL 60061, USA or other designated location. The product must be packaged in the original carton and packing material or an equivalent package and must have the assigned RMA number clearly marked on the carton. Returned Product received without an RMA number will be returned to the sender.

III. WARRANTY CONDITIONS:

This is the complete warranty for the Products manufactured by Telular and sold to Buyer. Telular assumes no obligation or liability for additions or modifications to this warranty unless made in writing and signed by an officer of Telular. Unless made in separate written agreement between Telular and Buyer, Telular does not warrant the installation, field maintenance or service of the Products or parts.

TELULAR CANNOT BE RESPONSIBLE IN ANY WAY FOR ANY ANCILLARY EQUIPMENT NOT FURNISHED BY TELULAR WHICH IS ATTACHED TO OR USED IN CONNECTION WITH THE PRODUCTS OR FOR OPERATION OF THE PRODUCTS WITH ANY ANCILLARY EQUIPMENT AND ALL SUCH EQUIPMENT IS EXPRESSLY EXCLUDED FROM THIS WARRANTY. FURTHERMORE, TELULAR CANNOT BE RESPONSIBLE FOR ANY DAMAGE TO THE PRODUCTS RESULTING FROM THE USE OF ANCILLARY EQUIPMENT NOT FURNISHED BY TELULAR FOR USE WITH THE PRODUCTS.

WHEN THE PRODUCT IS USED IN CONJUNCTION WITH ANCILLARY OR PERIPHERAL EQUIPMENT NOT MANUFACTURED BY TELULAR, TELULAR DOES NOT WARRANT THE OPERATION OF THE PRODUCT/PERIPHERAL COMBINATION, AND TELULAR SHALL HONOR NO WARRANTY CLAIM WHERE THE PRODUCT IS USED IN SUCH A COMBINATION AND IT IS DETERMINED BY TELULAR THAT THERE IS NO FAULT WITH THE PRODUCT. TELULAR DISCLAIMS LIABILITY FOR RANGE, COVERAGE, AVAILABILITY, OR OPERATION OF THE CELLULAR SYSTEM WHICH IS PROVIDED BY THE CARRIER.

IV. WHAT THIS WARRANTY DOES NOT COVER:

(a) Subsequent upgrades and enhancements to the Product. (b) Defects, non-compliance or damage resulting from use of the Product in other than its normal and customary manner or environment. (c) Defects, noncompliance or damage from misuse, lightening, accident or neglect. (d) Defects, noncompliance or damage from improper testing, operation, maintenance, installation, adjustment, or any alteration or modification of any kind. (e) Product disassembled or repaired in such a manner as to adversely affect performance or prevent adequate inspection and testing to verify any warranty claim. (f) Product which has had the serial number removed or made illegible. (g) Defects, non-compliance or damage due to spills of food or liquid. (h) All plastic surfaces and all other externally exposed parts that are scratched or damaged due to customer normal use. (i) Costs and expenses, including without limitation handling, labor and transportation, incurred in returning Product for warranty service to Telular's Repair Center. (j) Repair, programming or servicing by someone other than Telular.

V. GENERAL PROVISIONS:

THIS WARRANTY IS GIVEN IN LIEU OF ALL OTHER EXPRESS OR STATUTORY WARRANTIES. IMPLIED WARRANTIES, INCLUDING WITHOUT LIMITATION IMPLIED WARRANTIES OF MERCHANTABILITY, FITNESS FOR A PARTICULAR PURPOSE, TITLE, INFRINGEMENT, DELIVERY, NEGLIGENCE AND PERSONAL INJURY, ARE DISCLAIMED. FURTHER, AS THE CELLULAR CARRIER IS NOT CONTROLLED BY TELULAR, NO WARRANTY IS MADE AS TO COVERAGE, AVAILABILITY OR GRADE OF SERVICE PROVIDED BY THE CELLULAR CARRIER. IN NO EVENT SHALL TELULAR BE LIABLE FOR DAMAGES IN EXCESS OF THE PURCHASE PRICE OF THE PRODUCT, FOR ANY LOSS OF USE, LOSS OF TIME, INCONVENIENCE, COMMERCIAL LOSS, LOST PROFITS OR SAVINGS OR OTHER INCIDENTAL, SPECIAL OR CONSEQUENTIAL DAMAGES ARISING OUT OF THE USE OR INABILITY TO USE SUCH PRODUCT TO THE FULL EXTENT SUCH MAY BE DISCLAIMED BY LAW. SOME JURISDICTIONS DO NOT ALLOW THE EXCLUSION OR LIMITATIONS OF INCIDENTAL OR CONSEQUENTIAL DAMAGES OR LIMITATION ON HOW LONG AN IMPLIED WARRANTY LASTS.

VI. SOFTWARE PROVISIONS:

Laws in the United States and other countries preserve for Telular certain exclusive rights for copyrighted Telular software such as the exclusive rights to reproduce in copies and distribute copies of such Telular software. Telular software may be copied into, used in and redistributed with only the Product associated with such Telular software. No other use, including without limitation, disassembly of such Telular software or exercise of exclusive rights in such Telular software is permitted and Telular reserves all rights not expressly granted in this Limited Commercial Warranty.

Patents:

Telular Corporation products are protected and manufactured under one or more of the following U.S. patents and related international patents and patents pending relating thereto: 4,658,096; 4,737,975; 4,775,997; 4,868,519; 4,922,517; 5,134,651; 5,361,297; 5,469,494; 5,046,085; 5,715,296, 6,775,522, 6,785,517

Trademarks:

Telular Corporation owns the following registered trademarks: TELULAR and design, TELULAR, CELJACK, MAXJACK, TELCEL, HEXAGON LOGO, PHONECELL, CELSERV, TELGUARD, CPX, and AXCELL.

APPENDIX A
PC SERIAL PORT SETUP FOR CIRCUIT SWITCHED DIGITAL FAX AND
DATA (not for use with GPRS)
(SX6P-300G series only)

Requirements:

- GSM account with your network service provider including a circuit switched data and fax facility.
- PC, laptop, notebook with a RS232 serial port.
- Windows 2000 or better.
- RS-232 Cable (DB9 to DB15).

NOTE: When all of the above have been satisfied, you may proceed.

Modem Setup

1. Power on your PC or device that is connected to the SX6P.
2. Click the "Start" button, select "SETTINGS" and then "CONTROL PANEL". Once the Control Panel window appears double click the MODEMS icon button. The modem properties window will appear.

NOTE: Other modems may appear in the list of installed modems.

3. Click the ADD button to install a new modem device for the phonecell.

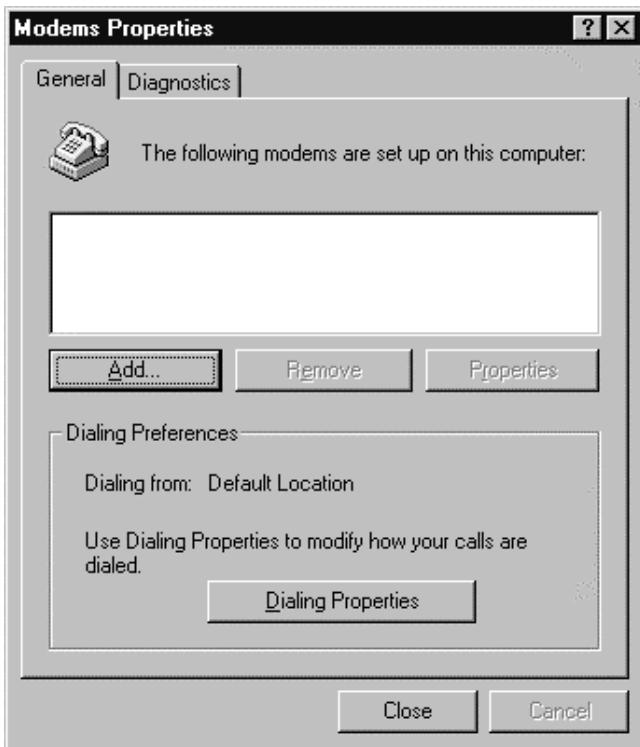

4. The Install New Modem window may appear asking for the type of modem to install. Select "Other" followed by clicking the NEXT button. If this window does not appear, go to Step 5.



5. The Install New Modem window will appear. Then, click on the "Don't detect my modem option" followed by clicking the NEXT button.

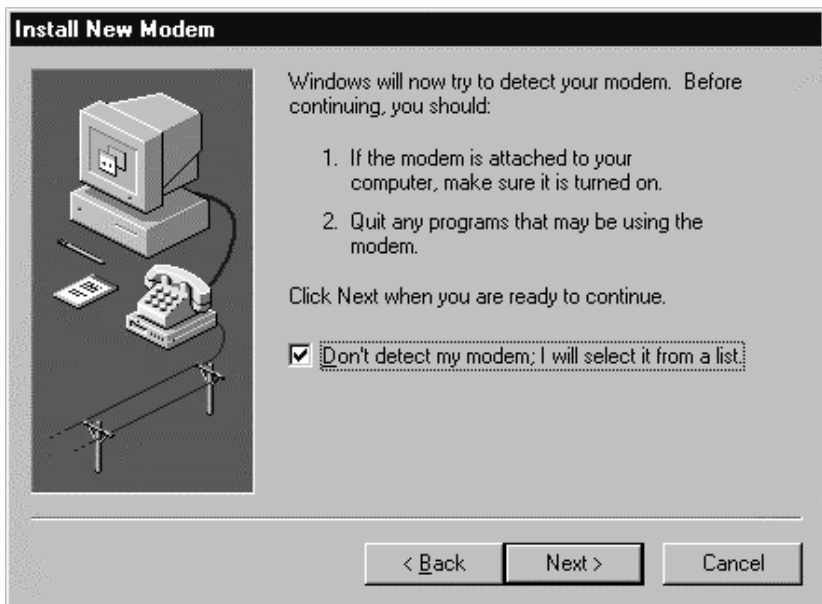

6. The Install New Modem will update again to select the manufacturer and the modem model. Select "Standard Modem Types" from the Manufacture's list. Select "Standard 19200 bps Modem" from the Models list then click next.

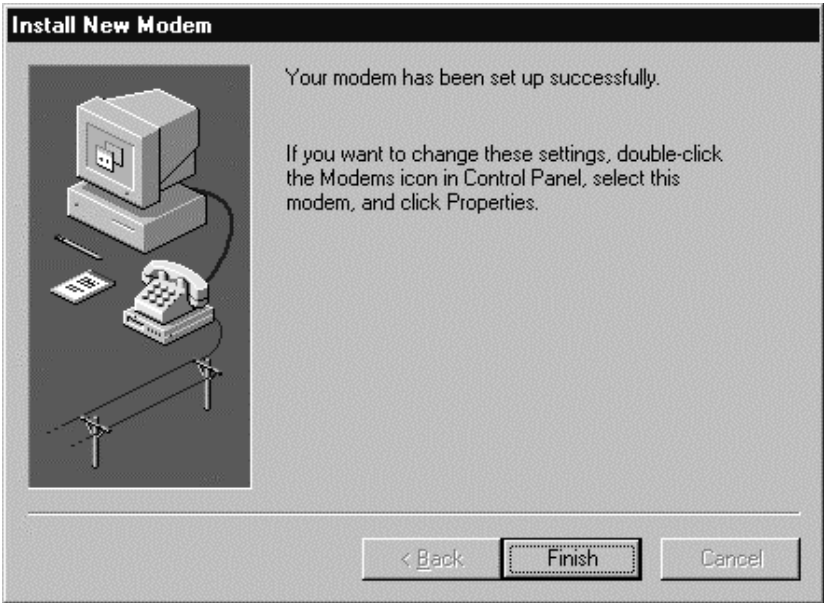

7. The Install New Modem will update to select the COM port. Select the COM port that will be connected to the SX6P then click Next. Windows will now create a modem configuration file for the Phonecell © SX6P. This may take several minutes.

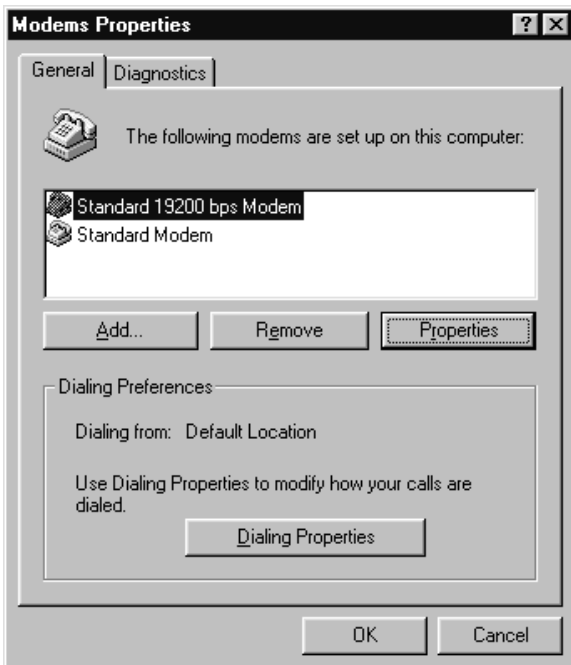

- The Modems Properties window should appear. Click on the Properties button.
- The Standard 19200 bps Modem Properties window will open in the General tab. Set as shown with the COM port you have selected.

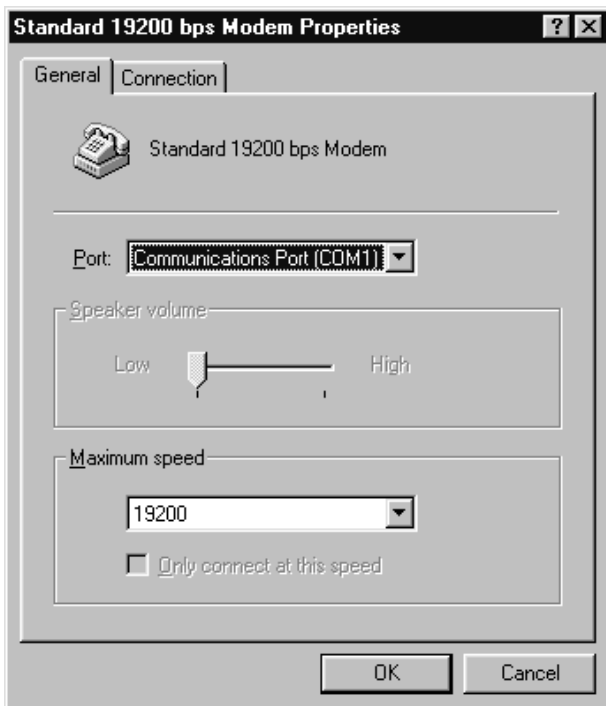

- Then click on the Connection tab. Set as shown below.

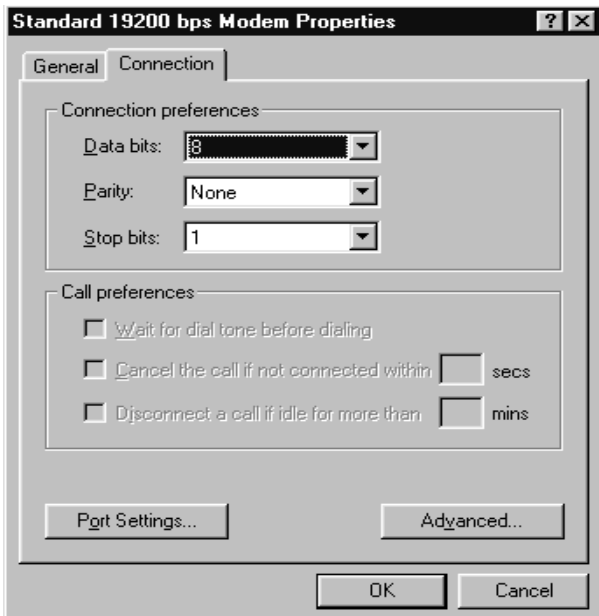

11. Click on the Advanced button. Set as shown.

12. Click on OK and Close to back out of each window. Your modem is now set up.

NOTE: When using the SX6P for PC fax operation, make sure the modem connection uses software flow control. When using PC data, either hardware or software flow control can be used, as long as the PC application (and modem) match the SX6P's configuration. The SX6P defaults to hardware flow control. The following AT commands are used to change the SX6P's flow control.

Enable Software Flow Control: AT+IFC=1,1
Enable Hardware Flow Control: AT+IFC=2,2
Disable Flow Control: AT+IFC=0,0

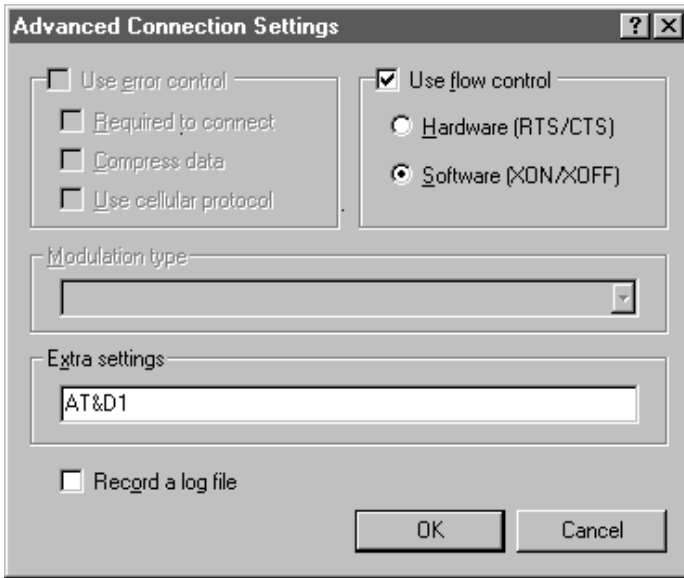



647 North Lakeview Parkway
Vernon Hills, Illinois 60061, USA
Tel: 847-247-9400 • Fax: 847-247-0021
E-mail: support@telular.com
<http://www.telular.com>